



**DIZAINA
FABRIKA**

FRONTO SLAT PANELS

FRONTO IS AN EXTERIOR
VERSION OF THE POPULAR
SLATS ON THE MARKET
TODAY.



FOR USE ON WALLS AND
CEILINGS. DEPENDING ON
THE PROJECT, THE PANELS
WILL WORK WELL ON THE
ENTIRE BUILDING OR AS A
SINGLE ACCENT ON THE
FAÇADE.



FRONTO CAN BE COMBINED
WITH OTHER VOX FAÇADE
PANELS SUCH AS INFRATOP,
VIFRONT AND MAX-3.





ADVANTAGES



Natural wood structure
and texture



Moisture resistance



System click



No painting and
maintenance required



Horizontal and
vertical installation



Walls and ceilings
application



Lightweight for easy
installation



Guarantee

TECHNOLOGY

- Panels are offered in 2 variants: as a panel made in co-extrusion technology and in three-layer Max-3 technology
- The staining of the profiles in the colors of the wood was obtained thanks to the modern printing technology Termodruk and Termodruk 2.
- Designation: SVP(U)-06 for co-extruded panels and SXP(U)-06 for panels made in Max-3 technology



MAX-3 TECHNOLOGY

It is an innovative 3-layer extrusion technology.

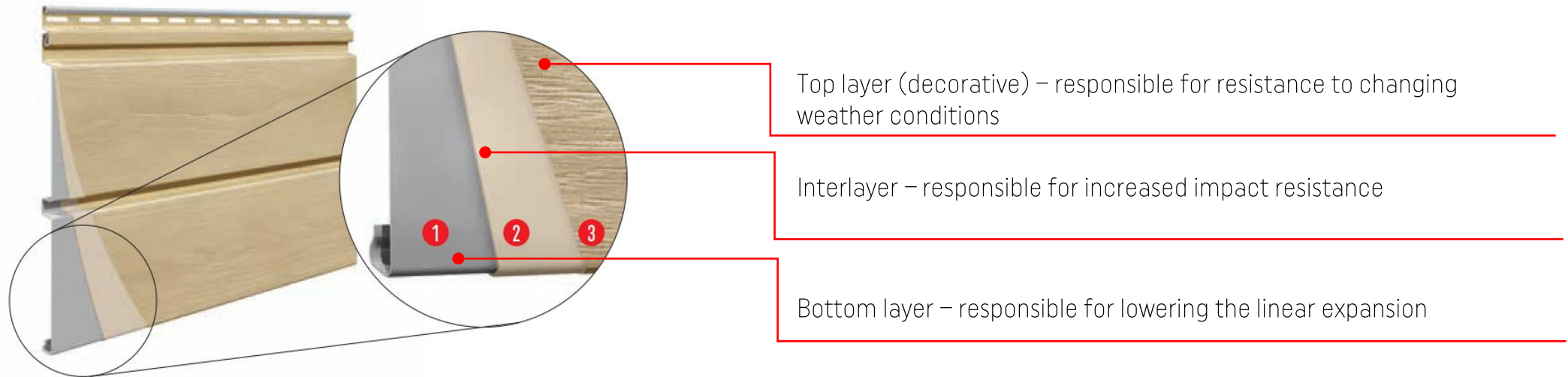

Thanks to this technology, the panel has exceptional impact resistance comparable to metal panels. Compared to standard vinyl cladding, the impact resistance is three times higher and withstands an impact force of 13.5 J. In addition, the panel has high resistance to low and high temperatures.

SYSTEM ELEMENTS

SV(P/PU)/SX(P/PU)-06

Slat panel

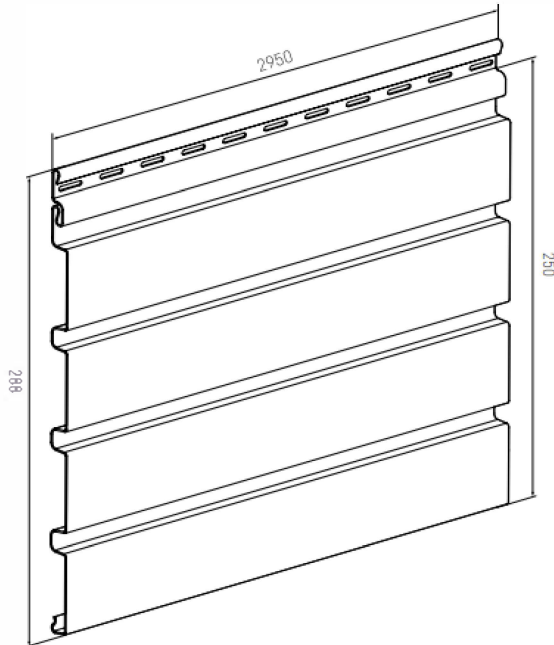

SV-11
Starting trim

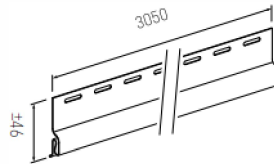

SV-11,5
Lower ventilation trim

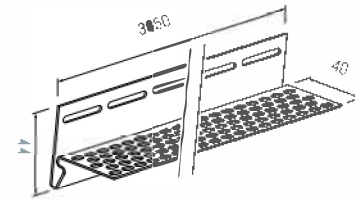

SV(P/PU)-12
Outside corner

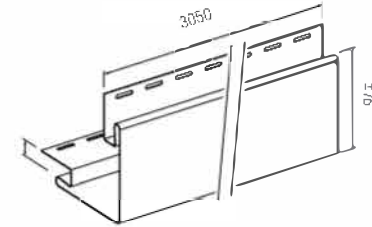

SV(P/PU)-13
Inside corner

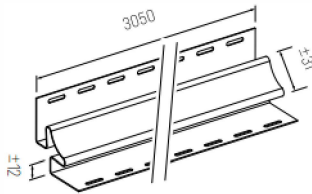

SV(P/PU)-15
J trim

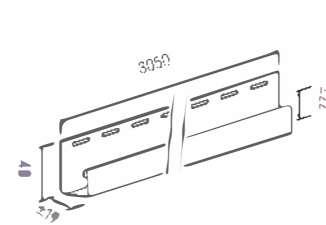

SV(P/PU)-18
Joint trim

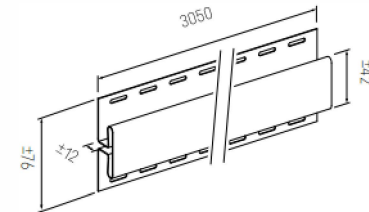

PANEL SHAPE

The panel has 4 narrow slats and grouts which refracts light and creates interesting contrasts.

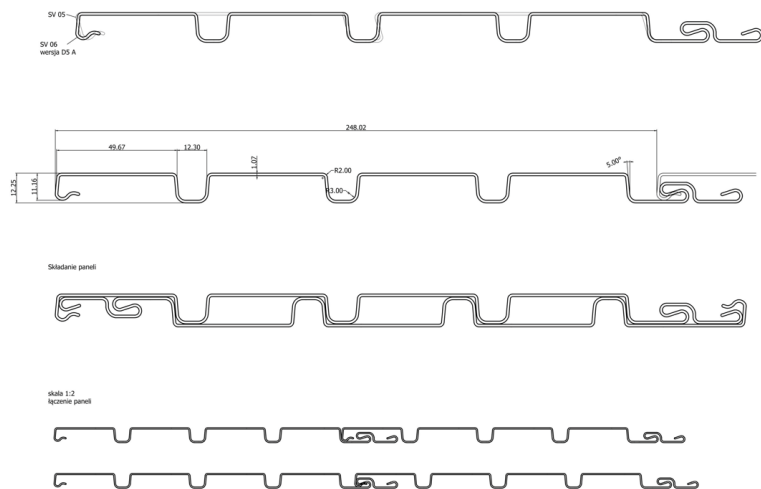

MODERN SOLUTIONS



COLOURS

The colours of SVP(U)-06 and SXP(U)-06 panels correspond to the colours of panels and trims offered in Infratop and Max-3 systems



Oak



Honey Oak



Winchester Oak



Golden Oak



Walnut

INSTALLATION

- The shape of the panel allows for both vertical and horizontal mounting
- The panels are mounted on a standard substructure (metal or wooden) without the need for special tools.
- Finishing strips identical to Infratop and Max-3 systems
- Slat panels mean clean installation with no dust during processing.
- The click system and pre-punched mounting holes streamline their connection, which greatly reduces installation time, outperforming plaster and wooden façades.



